

Fiberglass Strongwell Industrial Stainless Steel Reinforced Plastic Grating Suppliers

A. Fiberglass Grating

The glass fiber reinforced plastic grid (FRP) is a glass fiber reinforced material, unsaturated polyester resin matrix, through a special processing compound with a lot of space, FRP grid can be used as structure Materials, corrosive environment to the floor, trench cover, ship deck, stairs, plank road and so on.

Moulded grating structure

- ① Integral one-piece construction distributes the load to adjoining cross bars and bearing bars for even load distribution.
- ② Glass roving winding in alternating layers within thermoset resins.
- ③ Slip-resistant top surface.

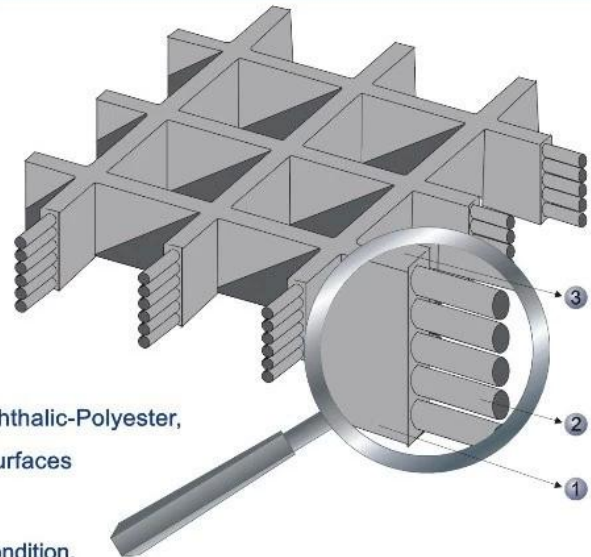

Material Specification



Resin systems available Orthophthalic-Polyester, Isophthalic-Polyester, Vinyl Ester. The use of various resins reinforcements and surfaces can result in variations of up to 15% in load data.

Fiberglass system available C-glass: suitable for acid condition.
E-glass: better strength and water resistant.

B. Characteristics of Fiberglass Grating

1. Excellent load capacity
2. Light, high impact
3. Slip and age-resistant
4. Corrosion & resistant to chemicals
5. Non-magnetic and insulation
6. Fire resistant

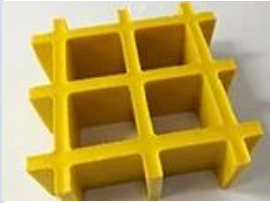
C. Fiberglass Grating Type

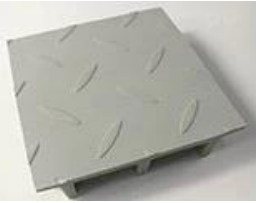
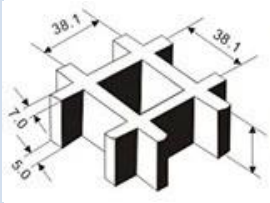
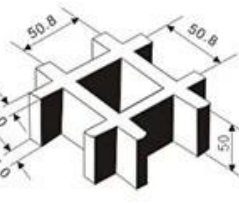
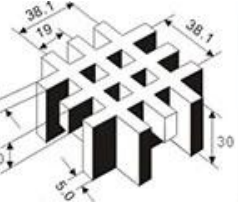
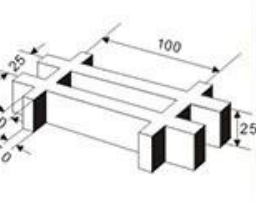
Type of Fiberglass Grating				
	Concave	Soft	Grind	Covered
Surface type				
	38 x 38	50 x 50	38x38x19x19	25x100
Structure (partial show)				
Thickness	25 mm 30 mm 38 mm	50 mm	30 mm	25 mm

D. Package & Delivery

Package	Delivery
1.Packed on plywood palet	1. Samples: 2-3 dyas
2.Packed in case of plywood	2. Mass production: 7-15 business days after receiving payment
3.Load in container directly	3. Terms of delivery: EXW, FOB. CIF, DDP all can be accepted



E. Fiberglass Grating Applications

1. Industrial areas: such as chemical plants / plating plant operating platform, maintenance platform, photovoltaic power generation platform walkway
2. Sewage treatment areas: sewage treatment plant corridor and sealing cap
3. Areas of Municipal Engineering: Pedestrian Walkway, Trench / Cable Trench Cover, Tree Grating
4. Area of marine applications: boat platforms or bridge materials, offshore oil platform

5. Other civilian areas: such as car wash, cattle and sheep farms and so on

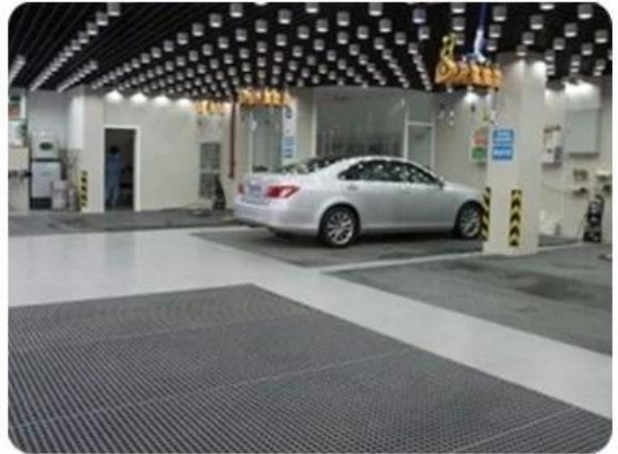

F. Factory Profiles

Foreth Industrial Co., Ltd is a fast developing company which is mainly specialized in plastic coated fiber (FRP) products and operates in a global market. Foreth's team provides customers with FRP sheets, FRP sandwich FRF grids, composite roofing, FRP profiles, FRP roof sheets, etc., with a wide range of applications throughout the construction, marine, off road, rail, water treatment and engineering.

Moreover, we have extensive experience in exporting and supplying high quality products and excellent service.

Please feel free to contact us if any inquiry you may have and we will be happy to assist you. We hope to be your reliable supplier & stable partner setting up a lot of time as well as a joyful business relationship with your esteemed company!

WHY CHOOSE US



Foreth Industrial Co., Ltd. is a rapid development of enterprises, mainly Specializing in glass fiber reinforced plastic (fiber reinforced plastic) products and in global market. We have been in the glass fiber reinforced plastic industry for 15 years.

[**More**](#)

