

25mm Thickness Yellow Concave Fiberglass Reinforced Plastic FRP Grating

A. FRP Graing

Glass fiber reinforced plastic (FRP) grating is a glass fiber reinforced material, unsaturated polyester resin matrix, through a special processing composite with a lot of space, FRP grating can be used as structure Materials, corrosive environment for the floor, trench cover, platform, ship deck, stairs, plank road and so on.

Moulded grating structure

- ① Integral one-piece construction distributes the load to adjoining cross bars and bearing bars for even load distribution.
- ② Glass roving winding in alternating layers within thermoset resins.
- ③ Slip-resistant top surface.

Material Specification

Resin systems available Orthophthalic-Polyester, Isophthalic-Polyester, Vinyl Ester. The use of various resins reinforcements and surfaces can result in variations of up to 15% in load data.

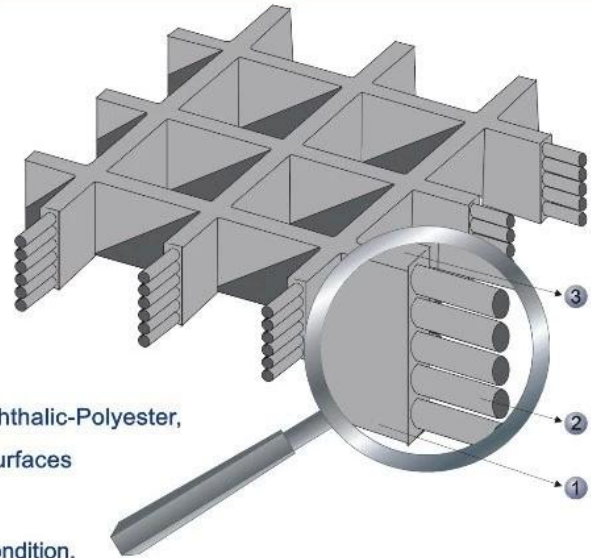

Fiberglass system available C-glass: suitable for acid condition.
E-glass: better strength and water resistant.



B. FRP Grating Features

1. Exellent loadability
2. Lightweight, high impact
3. Slip and age resistant
4. Corrosion & chemical resistant
5. Non-magnetic&insulation
6. Fire resistant

C. FRP Grating Type

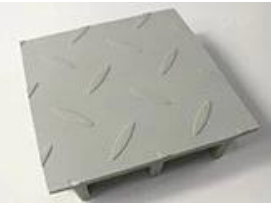
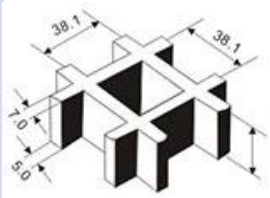
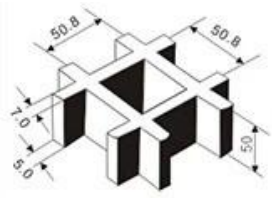
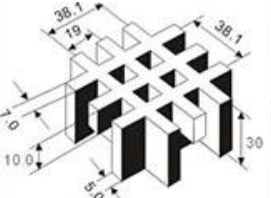
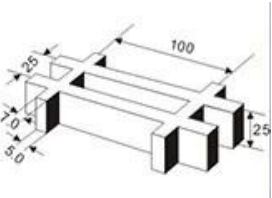
FRP Grating Type		Concave	Smooth	Gritted	Covered
Surface type					
		38x38	50x50	38x38x19x19	25x100
Structure (part show)					

Thickness

25mm 30mm 38mm

50mm

30mm

25mm

D. Package & Delivery

Package

- 1.Packed on plywood pallet
- 2.Packed in plywood case
- 3.Load in container directly

Delivery

1. Samples: 2-3 dyas
2. Mass production: 7-15 working days after receive payment
3. Delivery terms: EXW, FOB. CIF, DDP all can be accepted



E. FRP Grating Applications

1. Industrial areas: such as chemical plants / plating plant operating platform, maintenance platform, photovoltaic power generation platform walkway
2. Sewage treatment areas: sewage treatment plant aisle and sealing cover
3. Municipal Engineering areas: Pedestrian Walkway, Trench / Cable Trench Cover, Tree Grating
4. Marine applications areaa: Boat decks or bridge materials, Offshore oil platform

5. Other civilian areas: such as car washing, cattle and sheep farms and so on

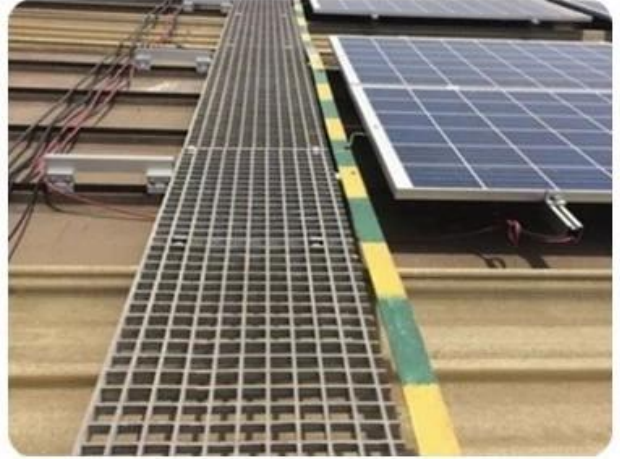

F. Factory Profiles

Foreth Industrial Co., Ltd is a fast-developing enterprise which is mainly specialized in FRP(fiber reinforced plastic) products, and operates in a global marketplace. Foreth team supply clients with FRP sheets, FRP sandwich panels FRP gratings, composite manhole covers,FRP profiles, FRP roofing sheets etc,with a wide range of applications across the construction,marine,off highway,rail,water treatment and engineering industries.

Additionally, we have rich experience in exporting and supplying high quality products and excellent service.

Feel free to contact us if any query you may have and we will be happy to assist you.We hope to be your reliable supplier & stable partner by establishing long time as well as joyful business relationship with your esteemed company!

WHY CHOOSE US



Foreth Industrial Co., Ltd. is a rapid development of enterprises, mainly Specializing in glass fiber reinforced plastic (fiber reinforced plastic) products and in global market. We have been in the glass fiber reinforced plastic industry for 15 years.

[**More**](#)

